

# BCR12CS-12LB

Triac  
Medium Power Use

R07DS0225EJ0400  
(Previous: REJ03G0470-0300)  
Rev.4.00  
Dec 14, 2010

## Features

- $I_{T(RMS)}$  : 12 A
- $V_{DRM}$  : 600 V
- $I_{FGT}$ ,  $I_{RGT}$ ,  $I_{RGT III}$  : 30 mA (20 mA)<sup>Note6</sup>
- The product guaranteed maximum junction temperature of 150°C
- Non-Insulated Type
- Planar Passivation Type

## Outline

|   |   |   |   |   |  |
|---|---|---|---|---|--|
| RENESAS Package code: PRSS0004AE-B<br>(Package name: LDK(S)-(1) ) | RENESAS Package code: PRSS0004AB-A<br>(Package name: TO-220S) |  |  |  | 1. T <sub>1</sub> Terminal<br>2. T <sub>2</sub> Terminal<br>3. Gate Terminal<br>4. T <sub>2</sub> Terminal |
|---|---|---|---|---|--|

## Applications

Contactless AC switch, light dimmer, electronic flasher unit, control of household equipment such as TV sets, stereo systems, refrigerator, washing machine, infrared kotatsu, carpet, electric fan, solenoid driver, small motor control, solid state relay, copying machine, electric tool, electric heater control, and other general purpose control applications

## Maximum Ratings

| Parameter  | Symbol    | Voltage class | Unit |
|--|-----------|---------------|------|
|  |           | 12            |      |
| Repetitive peak off-state voltage <sup>Note1</sup>     | $V_{DRM}$ | 600           | V    |
| Non-repetitive peak off-state voltage <sup>Note1</sup> | $V_{DSM}$ | 720           | V    |

| Parameter                      | Symbol           | Ratings      | Unit             | Conditions  |
|--------------------------------|------------------|--------------|------------------|---|
| RMS on-state current           | $I_{T(RMS)}$     | 12           | A                | Commercial frequency, sine full wave 360° conduction, T <sub>c</sub> = 123°C <sup>Note3</sup> |
| Surge on-state current         | $I_{TSM}$        | 120          | A                | 60Hz sinewave 1 full cycle, peak value, non-repetitive  |
| I <sup>2</sup> t for fusing    | I <sup>2</sup> t | 60           | A <sup>2</sup> s | Value corresponding to 1 cycle of half wave 60Hz, surge on-state current                      |
| Peak gate power dissipation    | $P_{GM}$         | 5            | W                |   |
| Average gate power dissipation | $P_{G(AV)}$      | 0.5          | W                |   |
| Peak gate voltage              | $V_{GM}$         | 10           | V                |   |
| Peak gate current              | $I_{GM}$         | 2            | A                |   |
| Junction temperature           | T <sub>j</sub>   | - 40 to +150 | °C               |   |
| Storage temperature            | T <sub>stg</sub> | - 40 to +150 | °C               |   |
| Mass                           | —                | 1.3          | g                | Typical value   |

Notes: 1. Gate open.

## Electrical Characteristics

| Parameter   | Symbol                | Min.                | Typ. | Max. | Unit                      | Test conditions  |
|---|-----------------------|---------------------|------|------|---------------------------|--|
| Repetitive peak off-state current                                       | $I_{\text{DRM}}$      | —                   | —    | 2.0  | mA                        | $T_j = 150^\circ\text{C}$ , $V_{\text{DRM}}$ applied                                       |
| On-state voltage  | $V_{\text{TM}}$       | —                   | —    | 1.6  | V                         | $T_c = 25^\circ\text{C}$ , $I_{\text{TM}} = 20\text{ A}$ ,<br>Instantaneous measurement    |
| Gate trigger voltage <sup>Note2</sup>                                   | I                     | $V_{\text{FGTI}}$   | —    | —    | 1.5                       | $T_j = 25^\circ\text{C}$ , $V_D = 6\text{ V}$ , $R_L = 6\ \Omega$ ,<br>$R_G = 330\ \Omega$ |
|   | II                    | $V_{\text{RGTI}}$   | —    | —    | 1.5                       |  |
|   | III                   | $V_{\text{RGTIII}}$ | —    | —    | 1.5                       |  |
| Gate trigger current <sup>Note2</sup>                                   | I                     | $I_{\text{FGTI}}$   | —    | —    | $30^{\text{Note6}}$       | $T_j = 25^\circ\text{C}$ , $V_D = 6\text{ V}$ , $R_L = 6\ \Omega$ ,<br>$R_G = 330\ \Omega$ |
|   | II                    | $I_{\text{RGTI}}$   | —    | —    | $30^{\text{Note6}}$       |  |
|   | III                   | $I_{\text{RGTIII}}$ | —    | —    | $30^{\text{Note6}}$       |  |
| Gate non-trigger voltage  | $V_{\text{GD}}$       | 0.2/0.1             | —    | —    | V                         | $T_j = 125^\circ\text{C}/150^\circ\text{C}$ , $V_D = 1/2 V_{\text{DRM}}$                   |
| Thermal resistance  | $R_{\text{th (j-c)}}$ | —                   | —    | 1.8  | $^\circ\text{C}/\text{W}$ | Junction to case <sup>Note3 Note4</sup>  |
| Critical-rate of rise of off-state commutating voltage <sup>Note5</sup> | $(dv/dt)_c$           | 10/1                | —    | —    | $\text{V}/\mu\text{s}$    | $T_j = 125^\circ\text{C}/150^\circ\text{C}$  |

Notes: 2. Measurement using the gate trigger characteristics measurement circuit.

3. Case temperature is measured on the  $T_2$  tab.

4. The contact thermal resistance  $R_{\text{th (c-f)}}$  in case of greasing is  $1.0^\circ\text{C}/\text{W}$ .

5. Test conditions of the critical-rate of rise of off-state commutating voltage is shown in the table below.

6. High sensitivity ( $I_{\text{GT}} \leq 20\text{ mA}$ ) is also available. ( $I_{\text{GT}}$  item: 1)

| Test conditions   | Commutating voltage and current waveforms (inductive load) |
|---|--|
| 1. Junction temperature<br>$T_j = 125^\circ\text{C}/150^\circ\text{C}$<br>2. Rate of decay of on-state commutating current<br>$(di/dt)_c = -6.0\text{ A/ms}$<br>3. Peak off-state voltage<br>$V_D = 400\text{ V}$ |  |

Performance Curves

Maximum On-State Characteristics

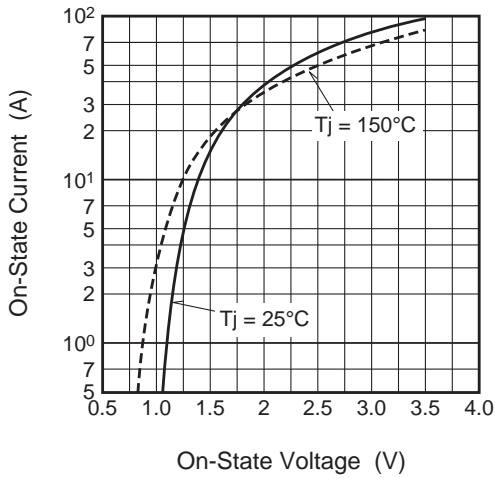

Rated Surge On-State Current

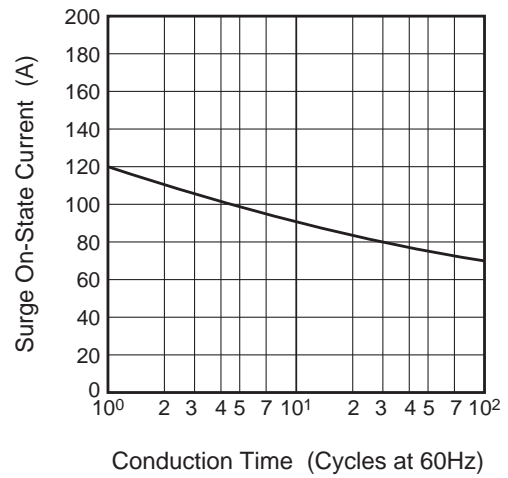

Gate Characteristics (I, II and III)

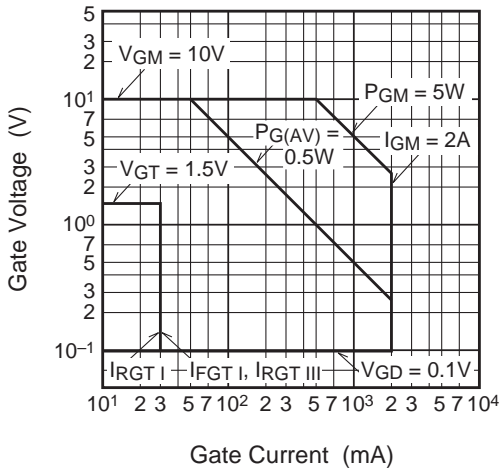

Gate Trigger Current vs. Junction Temperature

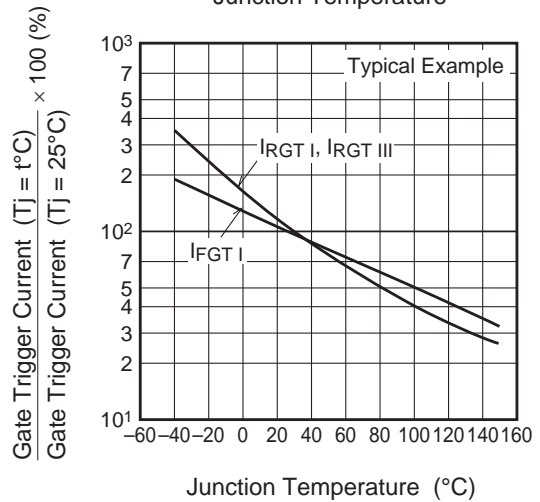

Gate Trigger Voltage vs. Junction Temperature

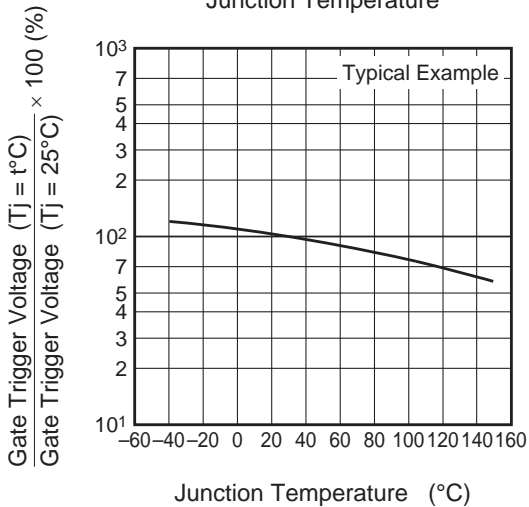

Maximum Transient Thermal Impedance Characteristics (Junction to case)

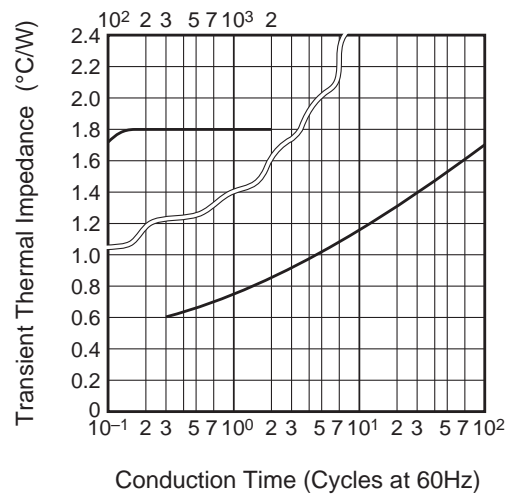

Maximum On-State Power Dissipation

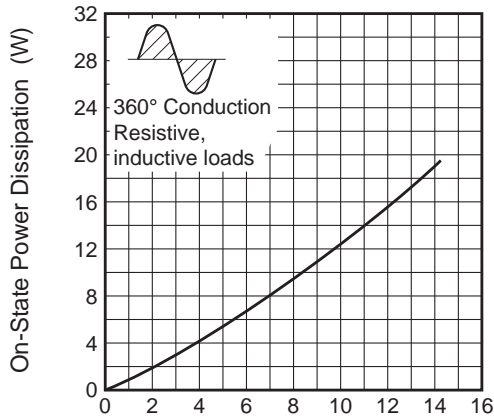

RMS On-State Current (A)

Allowable Case Temperature vs. RMS On-State Current

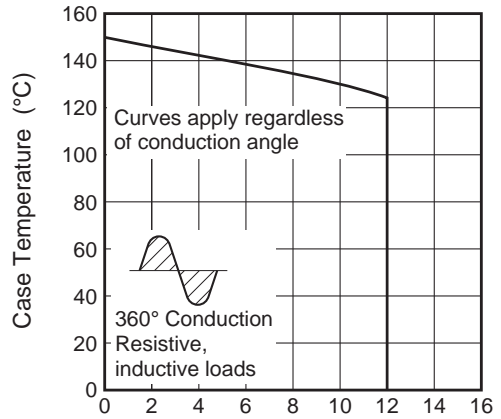

RMS On-State Current (A)

Allowable Ambient Temperature vs. RMS On-State Current

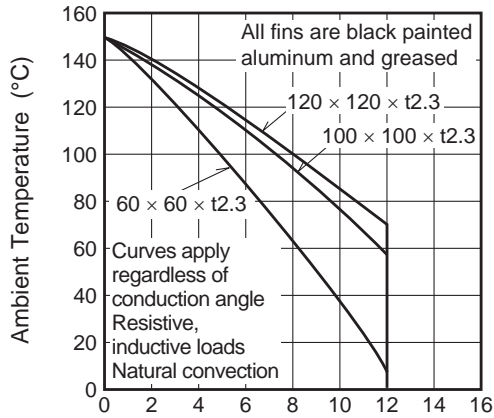

RMS On-State Current (A)

Allowable Ambient Temperature vs. RMS On-State Current

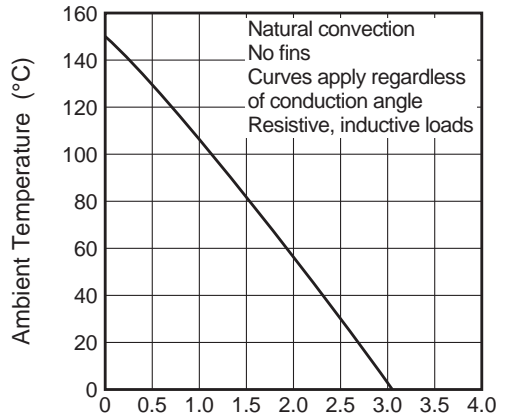

RMS On-State Current (A)

Repetitive Peak Off-State Current vs. Junction Temperature

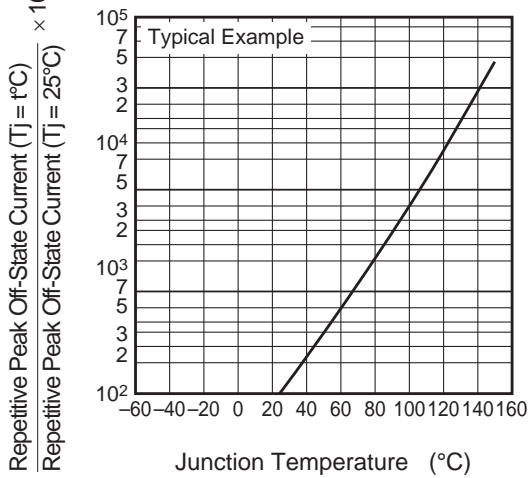

Junction Temperature (°C)

Holding Current vs. Junction Temperature

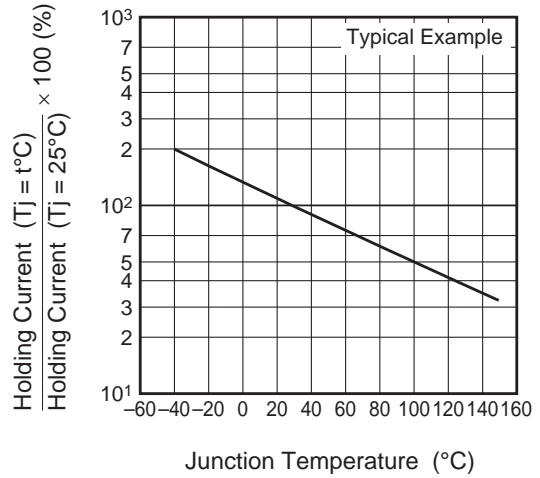

Junction Temperature (°C)

Latching Current vs. Junction Temperature

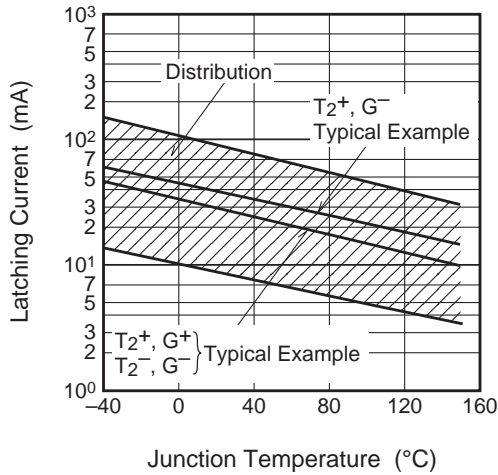

Breakover Voltage vs. Junction Temperature

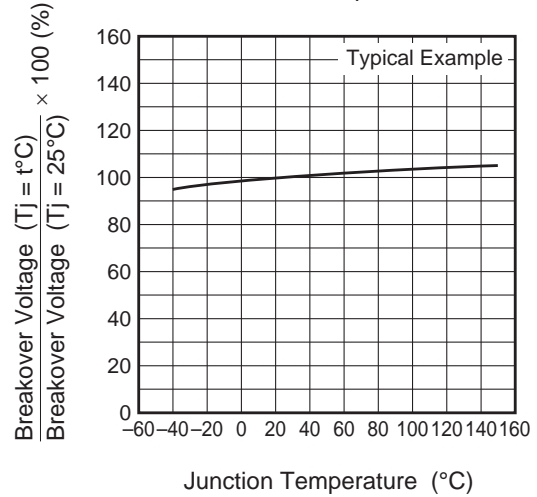

Breakover Voltage vs. Rate of Rise of Off-State Voltage (Tj=125°C)

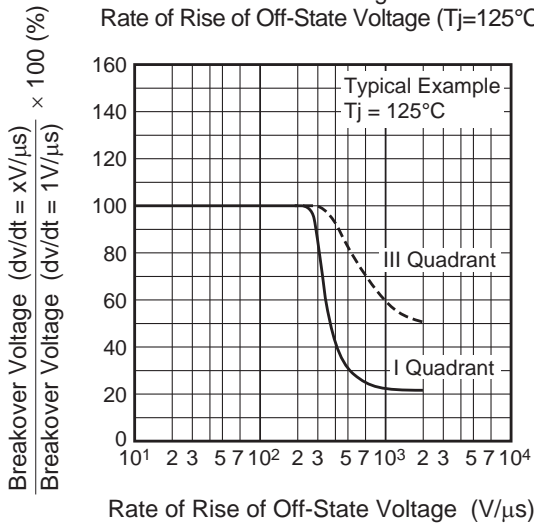

Breakover Voltage vs. Rate of Rise of Off-State Voltage (Tj=150°C)

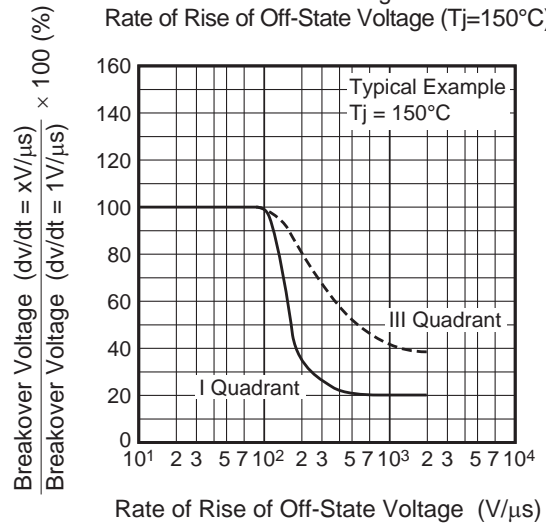

Commutation Characteristics (Tj=125°C)

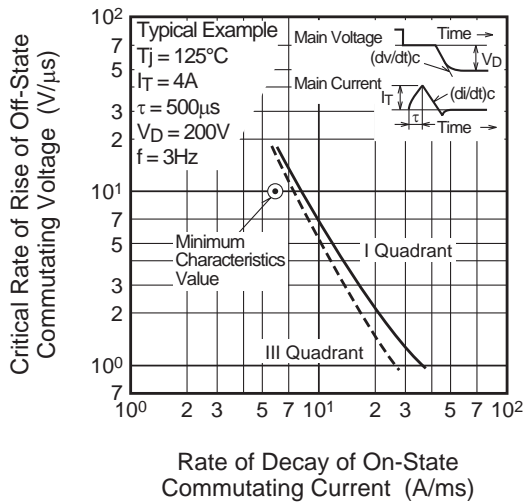

Commutation Characteristics (Tj=150°C)

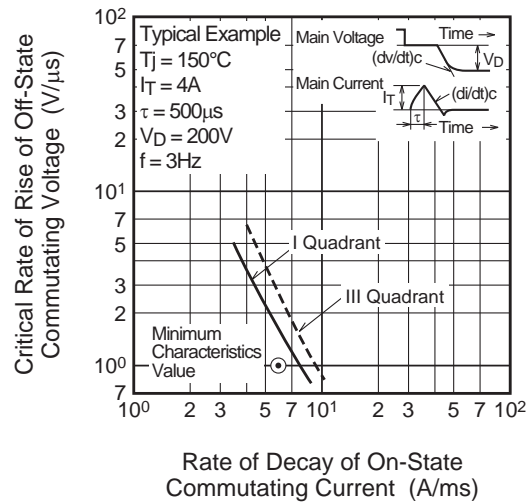

Gate Trigger Current vs. Gate Current Pulse Width

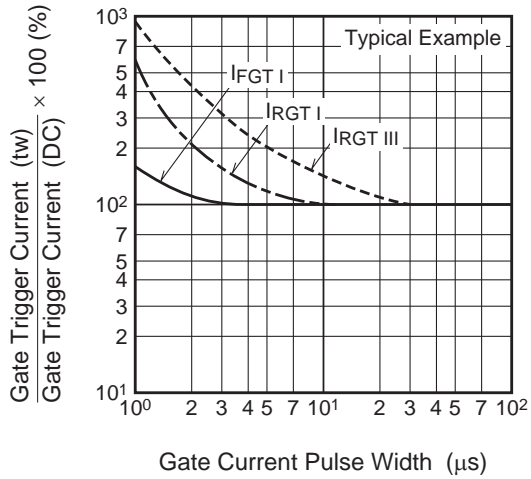

Gate Trigger Characteristics Test Circuits

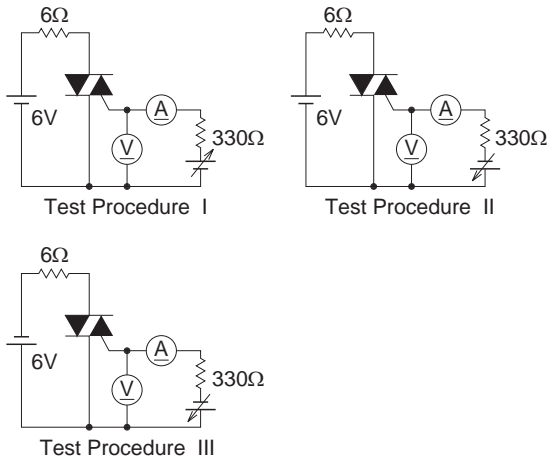

Recommended Circuit Values Around The Triac

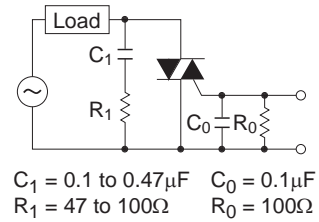

Package Dimensions

| Package Name  | JEITA Package Code | RENESAS Code | Previous Code                  | MASS[Typ.] |
|---------------|--------------------|--------------|--------------------------------|------------|
| LDBPAK(S)-(1) | SC-83              | PRSS0004AE-B | LDBPAK(S)-(1) / LDBPAK(S)-(1)V | 1.30g      |

Unit: mm

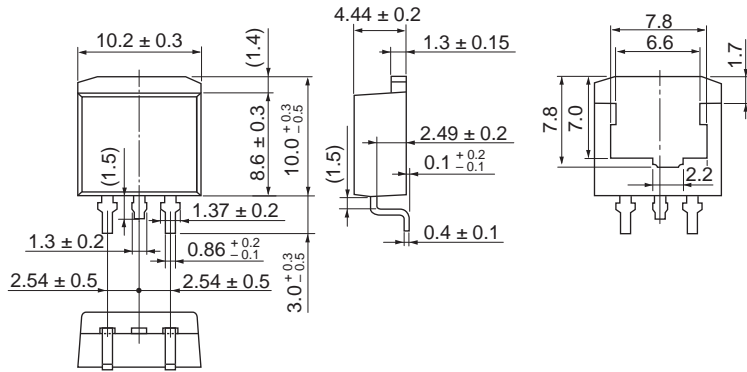

| Package Name | JEITA Package Code | RENESAS Code | Previous Code | MASS[Typ.] |
|--------------|--------------------|--------------|---------------|------------|
| TO-220S      | SC-83              | PRSS0004AB-A | TO-220S       | 1.2g       |

Unit: mm

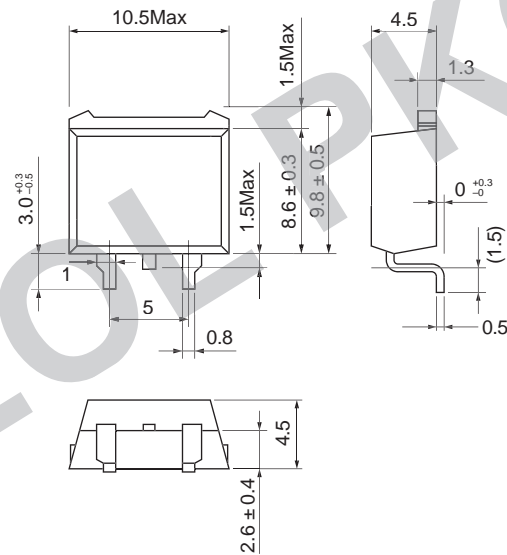

**Ordering Information**

| <b>Orderable Part Number</b> | <b>Packing</b> | <b>Quantity</b> | <b>Remark</b>         |
|------------------------------|----------------|-----------------|-----------------------|
| BCR12CS-12LB#B00             | Tube           | 50 pcs.         | —                     |
| BCR12CS-12LB-T11#B00         | Embossed Tape  | 1000 pcs.       | Taping direction "T1" |
| BCR12CS-12LB-T21#B00         | Embossed Tape  | 1000 pcs.       | Taping direction "T2" |



## Notice

- All information included in this document is current as of the date this document is issued. Such information, however, is subject to change without any prior notice. Before purchasing or using any Renesas Electronics products listed herein, please confirm the latest product information with a Renesas Electronics sales office. Also, please pay regular and careful attention to additional and different information to be disclosed by Renesas Electronics such as that disclosed through our website.
- Renesas Electronics does not assume any liability for infringement of patents, copyrights, or other intellectual property rights of third parties by or arising from the use of Renesas Electronics products or technical information described in this document. No license, express, implied or otherwise, is granted hereby under any patents, copyrights or other intellectual property rights of Renesas Electronics or others.
- You should not alter, modify, copy, or otherwise misappropriate any Renesas Electronics product, whether in whole or in part.
- Descriptions of circuits, software and other related information in this document are provided only to illustrate the operation of semiconductor products and application examples. You are fully responsible for the incorporation of these circuits, software, and information in the design of your equipment. Renesas Electronics assumes no responsibility for any losses incurred by you or third parties arising from the use of these circuits, software, or information.
- When exporting the products or technology described in this document, you should comply with the applicable export control laws and regulations and follow the procedures required by such laws and regulations. You should not use Renesas Electronics products or the technology described in this document for any purpose relating to military applications or use by the military, including but not limited to the development of weapons of mass destruction. Renesas Electronics products and technology may not be used for or incorporated into any products or systems whose manufacture, use, or sale is prohibited under any applicable domestic or foreign laws or regulations.
- Renesas Electronics has used reasonable care in preparing the information included in this document, but Renesas Electronics does not warrant that such information is error free. Renesas Electronics assumes no liability whatsoever for any damages incurred by you resulting from errors in or omissions from the information included herein.
- Renesas Electronics products are classified according to the following three quality grades: "Standard", "High Quality", and "Specific". The recommended applications for each Renesas Electronics product depends on the product's quality grade, as indicated below. You must check the quality grade of each Renesas Electronics product before using it in a particular application. You may not use any Renesas Electronics product for any application categorized as "Specific" without the prior written consent of Renesas Electronics. Further, you may not use any Renesas Electronics product for any application for which it is not intended without the prior written consent of Renesas Electronics. Renesas Electronics shall not be in any way liable for any damages or losses incurred by you or third parties arising from the use of any Renesas Electronics product for an application categorized as "Specific" or for which the product is not intended where you have failed to obtain the prior written consent of Renesas Electronics. The quality grade of each Renesas Electronics product is "Standard" unless otherwise expressly specified in a Renesas Electronics data sheets or data books, etc.  
"Standard": Computers; office equipment; communications equipment; test and measurement equipment; audio and visual equipment; home electronic appliances; machine tools; personal electronic equipment; and industrial robots.  
"High Quality": Transportation equipment (automobiles, trains, ships, etc.); traffic control systems; anti-disaster systems; anti-crime systems; safety equipment; and medical equipment not specifically designed for life support.  
"Specific": Aircraft; aerospace equipment; submersible repeaters; nuclear reactor control systems; medical equipment or systems for life support (e.g. artificial life support devices or systems), surgical implantations, or healthcare intervention (e.g. excision, etc.), and any other applications or purposes that pose a direct threat to human life.
- You should use the Renesas Electronics products described in this document within the range specified by Renesas Electronics, especially with respect to the maximum rating, operating supply voltage range, movement power voltage range, heat radiation characteristics, installation and other product characteristics. Renesas Electronics shall have no liability for malfunctions or damages arising out of the use of Renesas Electronics products beyond such specified ranges.
- Although Renesas Electronics endeavors to improve the quality and reliability of its products, semiconductor products have specific characteristics such as the occurrence of failure at a certain rate and malfunctions under certain use conditions. Further, Renesas Electronics products are not subject to radiation resistance design. Please be sure to implement safety measures to guard them against the possibility of physical injury, and injury or damage caused by fire in the event of the failure of a Renesas Electronics product, such as safety design for hardware and software including but not limited to redundancy, fire control and malfunction prevention, appropriate treatment for aging degradation or any other appropriate measures. Because the evaluation of microcomputer software alone is very difficult, please evaluate the safety of the final products or system manufactured by you.
- Please contact a Renesas Electronics sales office for details as to environmental matters such as the environmental compatibility of each Renesas Electronics product. Please use Renesas Electronics products in compliance with all applicable laws and regulations that regulate the inclusion or use of controlled substances, including without limitation, the EU RoHS Directive. Renesas Electronics assumes no liability for damages or losses occurring as a result of your noncompliance with applicable laws and regulations.
- This document may not be reproduced or duplicated, in any form, in whole or in part, without prior written consent of Renesas Electronics.
- Please contact a Renesas Electronics sales office if you have any questions regarding the information contained in this document or Renesas Electronics products, or if you have any other inquiries.  
(Note 1) "Renesas Electronics" as used in this document means Renesas Electronics Corporation and also includes its majority-owned subsidiaries.  
(Note 2) "Renesas Electronics product(s)" means any product developed or manufactured by or for Renesas Electronics.



### SALES OFFICES

Renesas Electronics Corporation

<http://www.renesas.com>

Refer to "<http://www.renesas.com/>" for the latest and detailed information.

**Renesas Electronics America Inc.**  
2880 Scott Boulevard Santa Clara, CA 95050-2554, U.S.A.  
Tel: +1-408-588-6000, Fax: +1-408-588-6130

**Renesas Electronics Canada Limited**  
1101 Nicholson Road, Newmarket, Ontario L3Y 9C3, Canada  
Tel: +1-905-898-5441, Fax: +1-905-898-3220

**Renesas Electronics Europe Limited**  
Dukes Meadow, Millboard Road, Bourne End, Buckinghamshire, SL8 5FH, U.K  
Tel: +44-1628-585-100, Fax: +44-1628-585-900

**Renesas Electronics Europe GmbH**  
Arcadiastrasse 10, 40472 Düsseldorf, Germany  
Tel: +49-211-65030, Fax: +49-211-6503-1327

**Renesas Electronics (China) Co., Ltd.**  
7th Floor, Quantum Plaza, No.27 Zhichunlu Haidian District, Beijing 100083, P.R.China  
Tel: +86-10-8235-1155, Fax: +86-10-8235-7679

**Renesas Electronics (Shanghai) Co., Ltd.**  
Unit 204, 205, AZIA Center, No.1233 Lujiazui Ring Rd., Pudong District, Shanghai 200120, China  
Tel: +86-21-5877-1818, Fax: +86-21-6887-7858 / -7898

**Renesas Electronics Hong Kong Limited**  
Unit 1601-1613, 16/F., Tower 2, Grand Century Place, 193 Prince Edward Road West, Mongkok, Kowloon, Hong Kong  
Tel: +852-2886-9318, Fax: +852-2886-9022/9044

**Renesas Electronics Taiwan Co., Ltd.**  
7F, No. 363 Fu Shing North Road Taipei, Taiwan  
Tel: +886-2-8175-9600, Fax: +886-2-8175-9670

**Renesas Electronics Singapore Pte. Ltd.**  
1 HarbourFront Avenue, #06-10, Keppel Bay Tower, Singapore 098632  
Tel: +65-6213-0200, Fax: +65-6278-8001

**Renesas Electronics Malaysia Sdn.Bhd.**  
Unit 906, Block B, Menara Amcorp, Amcorp Trade Centre, No. 18, Jln Persiaran Barat, 46050 Petaling Jaya, Selangor Darul Ehsan, Malaysia  
Tel: +60-3-7955-9390, Fax: +60-3-7955-9510

**Renesas Electronics Korea Co., Ltd.**  
11F., Samik Laviel'or Bldg., 720-2 Yeoksam-Dong, Kangnam-Ku, Seoul 135-080, Korea  
Tel: +82-2-558-3737, Fax: +82-2-558-5141